

FITTING INSTRUCTION

Clamp mark in acc. with		Cables joining
ISO	PN	
1	L	Left directional lights
2	+	Rear fog lights
3	31	Ground
4	R	Right directional lights
5	58R	Right side parking lights
6	54	Stoplights
7	58L	Left side parking lights

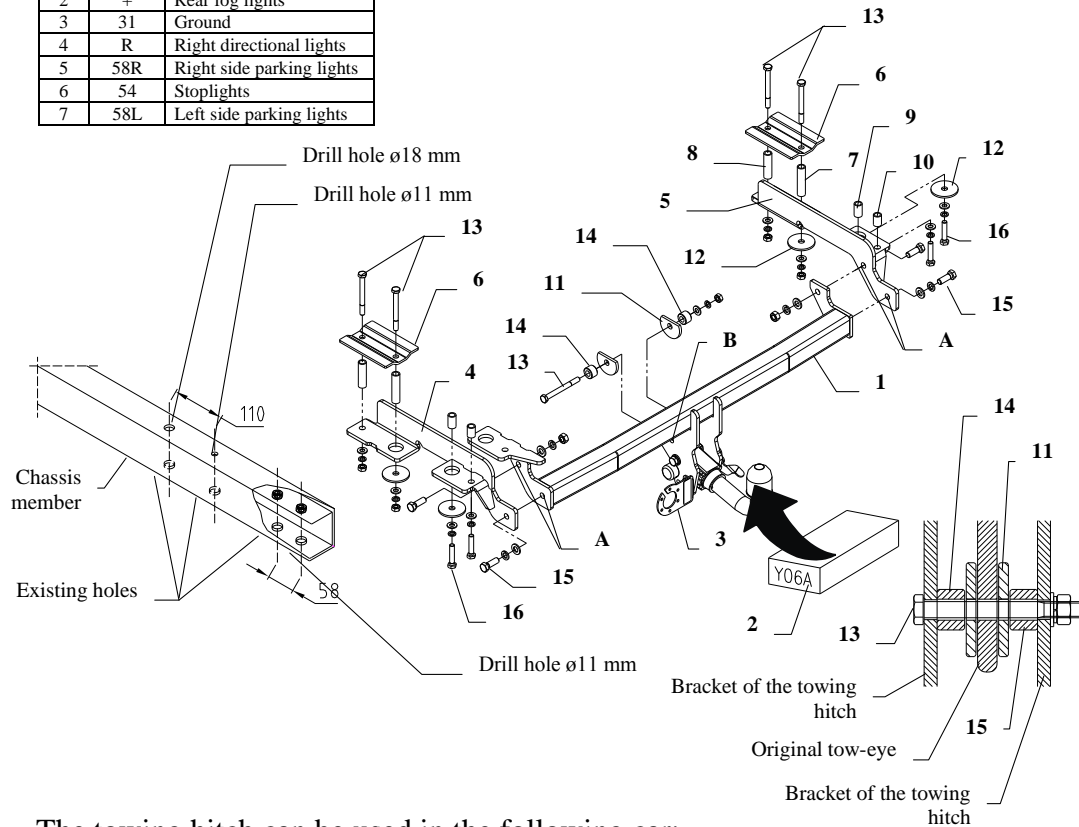

The towing hitch can be used in the following car:
HONDA CR-V 5-doors, produced since 06.1997 till 03.2002., catalogue no. **Y06A** and is prepared to tow trailers max total weight **1500 kg** and max vertical load **70 kg**.

From manufacturer

Thank you for buying our product. Their reliability has been confirmed in many tests. Reliability of towing hitch depends also on correct assembly and right operation. For this reasons we kindly ask to read carefully this instruction and apply to hints.

The towing hitch should be install in points described by a car producer.

The instruction of the assembly

1. To mount the towing hitch is necessary disassemble the bumper and exhaust box. Inside the carrier dismount the carpets.
2. Drill the holes in the chassis on the left and right side as shown on the drawing.
3. From under the car apply the side brackets (pos. 4 and 5) and through sleeves and fish-plates (pos. 6) applied in the boot and twist with bolts as shown on the drawing.
4. Fix the main bar of the towing hitch (pos. 1) through holes A by M12x35mm bolts (pos. 15) with the brackets.
5. Screw tight all installed screws.
6. Twist with screw M10x100mm (pos. 13) through hole B and the original tow-eye designed by the manufacturer. Use cut washers (pos. 11) and distance sleeves (pos. 14).
7. Cut out a fragment of dimensions 80x20mm, in the lever edge of the bumper in his axis.
8. Fix body of the automat and place tow-ball according to supplied instruction. Note! Remember to place socket plate (pos. 3) as shown on the drawing 1.
9. Install the exhaust, the bumper and put the carpets.
10. Tighten all bolts according to the torque shown in the table.
11. Connect the kit wires to the electric installation, in accordance of the instructions of the car.
12. Complete the possible decreases of the paint cover of towing hitch, originate during the mounting.

Torque settings for nuts and bolts 8,8:

M8	25 Nm	M10	55 Nm
M12	85 Nm	M14	135 Nm











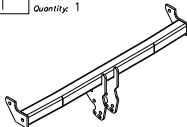











NOTE

After install the towing hitch you should get adequate note in registration book (at authorised service station).The car should be equipped with:

- Indicators
- Tow mirrors

After 1000km check all bolts and nuts. The ball of towing hitch must be always kept clear and conserve with a grease.

Towing hitch accessories:

Pos. 1 Name: Main bar Quantity: 1 	Pos. 6 Name: Fish-plate Quantity: 2 	Pos. 12 Name: Washer Quantity: 4 Dim.: Ø58xØ12x4mm 	Pos. 17 Name: Nut 8 B Quantity: 5 Dim.: M10 
Pos. 2 Name: Tow-ball Quantity: 1 	Pos. 7 Name: Sleeve L=72mm Quantity: 2 	Pos. 13 Name: Bolt 8,8 B Quantity: 5 Dim.: M10x100mm 	Pos. 18 Name: Plain washer Quantity: 4 Dim.: Ø 13 mm 
Pos. 3 Name: Socket plate Quantity: 1 	Pos. 8 Name: Sleeve L=62mm Quantity: 2 	Pos. 14 Name: Bolt 8,8 B Quantity: 4 Dim.: M12x35mm 	Pos. 19 Name: Plain washer Quantity: 9 Dim.: Ø 10,5 mm 
Pos. 4 Name: Left bracket Quantity: 1 	Pos. 9 Name: Sleeve L=30mm Quantity: 2 	Pos. 15 Name: Distance sleeve Quantity: 2 	Pos. 20 Name: Spring washer Quantity: 4 Dim.: Ø 12,2 mm 
Pos. 5 Name: Right bracket Quantity: 1 	Pos. 10 Name: Sleeve L=25mm Quantity: 2 	Pos. 16 Name: Nut 8 B Quantity: 2 Dim.: M12 	Pos. 21 Name: Spring washer Quantity: 9 Dim.: Ø 10,2 mm 
	Pos. 11 Name: Cut washer Quantity: 2 	Pos. 22 Name: Ball cover Quantity: 1 	



PPUH AUTO-HAK S. J.

Produkcja Haków Holowniczych
Henryk i Zbigniew Nejman
76-200 SŁUPSK ul. Słoneczna 16K
tel/fax (059) 8-414-414; 8-414-413
E-mail: office@autohak.com.pl
www.autohak.com.pl

Towing hitch (without electrical set)

Class: **A50-X** Cat. no. **Y06A**

Designed for:

Manufacturer: **HONDA**

Model: **CR-V**

Type: **5 doors**

produced since 06.1997 till 03.2000

Technical data:

D-value: 8,5 kN

maximum trailer weight: **1500 kg**

maximum vertical cup load: **70 kg**

Approval number acc. to regulations EKG/ONZ 55.01: **E20-55R-01 4209**

Foreword

This towing hitch is designed according to rules of safety traffic regulations. The towing hitch is a safety component and must be installed only by qualified personnel. Any alteration or conversion to the towinh hitch is prohibited and would lead to cancellation of design certification. Remove insulating compound and underseal from vehicle (if present) in the area of the matting surfaces of the towing hitch.

The vehicle manufacturer's specifications regarding trailer load and max. vertical cup load are decisive for driving, and values for the towing hitch must not be exceeded.

D-value formula:

$$\frac{\text{Max trailer weight [kg]} \times \text{Max vehicle weight [kg]}}{\text{Max trailer weight [kg]} + \text{Max vehicle weight [kg]}} \times \frac{9,81}{1000} = D \text{ [kN]}$$