

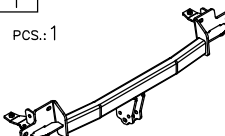

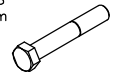







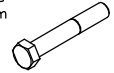





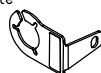

## Twoing hitch accessories:

Pos. 1 Main bar PCS.: 1 	Pos. 6 Bolt 8,8 B M12x75mm PCS.: 1 	Pos. 12 Bolt 8,8 B M8x30mm PCS.: 2 	Pos. 18 Spring washer 10,2 PCS.: 8 
	Pos. 7 Bolt 8,8 B M12x70mm PCS.: 1 	Pos. 13 Plain washer ø30xø10,5x2,5mm PCS.: 6 	Pos. 19 Spring washer ø8,2mm PCS.: 6 
Pos. 2 Tow ball PCS.: 1 	Pos. 8 Bolt 8,8 B M10x60mm PCS.: 2 	Pos. 14 Plain washer ø24xø8,4x2mm PCS.: 6 	Pos. 20 Nut 8 B M12 PCS.: 2 
Pos. 3 Socket plate PCS.: 1 	Pos. 9 Bolt 8,8 B M10x40mm PCS.: 2 	Pos. 15 Plain washer ø13mm PCS.: 2 	Pos. 21 Nut 8 B M10 PCS.: 4 
Pos. 4 Distance sleeve I ø25xø13mm L=12mm PCS.: 2 	Pos. 10 Bolt 8,8 B M10x30mm PCS.: 2 	Pos. 16 Plain washer ø10,5mm PCS.: 4 	Pos. 22 Ball cover PCS.: 1 
Pos. 5 Distance sleeve II ø25xø13mm L=31mm PCS.: 2 	Pos. 11 Bolt 8,8 B M8x40mm PCS.: 4 	Pos. 17 Spring washer ø12,2mm PCS.: 2 	



**PPUH AUTO-HAK Sp.J.**

Produkcja Zaczepów Kulowych  
Henryk & Zbigniew Nejman  
76-200 SŁUPSK ul. Słoneczna 16K  
tel/fax (059) 8-414-414; 8-414-413  
email: [office@autohak.com.pl](mailto:office@autohak.com.pl)  
[www.autohak.com.pl](http://www.autohak.com.pl)

## Towing hitch (without electrical set)

Class: **A50-X** Cat. no. **O06**

Designed for:

Manufacturer: **TOYOTA**

Model: **COROLLA**

Type: **3 doors, (E11)**

produced since 06.1997 till 12.2001

Technical data:

**D-value: 7,1 kN**

maximum trailer weight: **1200 kg**

maximum vertical cup mass: **75 kg**

**Approval number according to Directive 94/20/EC: e20\*94/20\*0627\*00**

## Foreword

This towbar is designed according to rules of safety traffic regulations. The towing hitch is a safety component and can be install only by qualified personnel. Any alteration or conversion of the towing hitch is prohibited and would lead to cancellation of design certification. Remove insulating compound and underseal from vehicle (if present) in the area of the matting surfaces of the towing hitch.

The vehicle manufacturer's specifications regarding trailer load and max. vertical cup load are decisive for driving whereat values for the towing hitch cannot be exceeded.

*D-value formula:*

$$\frac{\text{Max trailer weight [kg]} \times \text{Max vehicle weight [kg]}}{\text{Max trailer weight [kg]} + \text{Max vehicle weight [kg]}} \times \frac{9,81}{1000} = D \text{ [kN]}$$

## FITTING INSTRUCTION

Clamp mark in acc. with		Cables joining
ISO	PN	
1	L	Left directional lights
2	+	Rear fog lights
3	31	Ground
4	R	Right directional lights
5	58R	Right side parking lights
6	54	Stoplights
7	58L	Left side parking lights

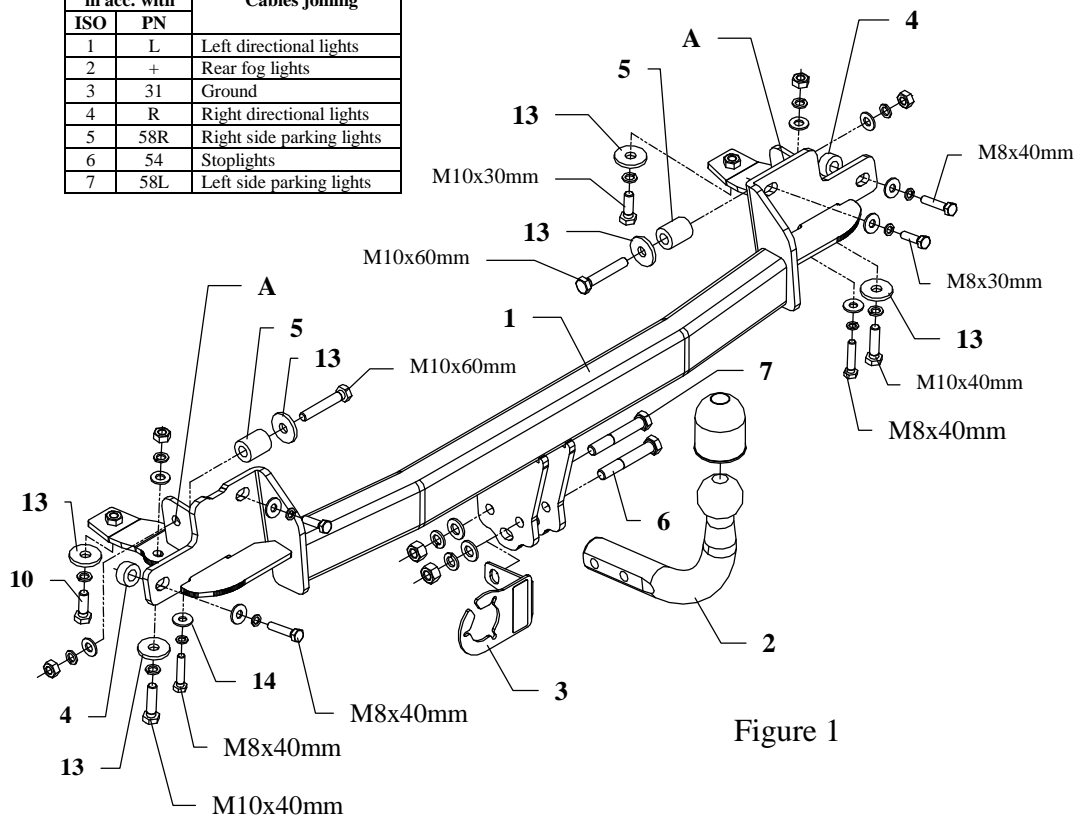

Figure 1

This towbar is designed to assembly in following car: **TOYOTA COROLLA, 3 doors, (E11)**, produced since 06.1997 till 12.2001, catalogue number **O06** and is prepared to tow trailers max total weight **1200 kg** and max vertical mass **75 kg**.

### *From manufacturer*

Thank you for buying our product. Their reliability has been confirmed in many tests. Reliability of towbar depends also on correct assembly and right operation. For this reasons we kindly ask to read carefully this instruction and apply to hints.

*The towbar should be install in points described by a car producer.*

## The instruction of the assembly

1. Disassemble a rear bumper.
2. Disassemble metal protective covers from chassis members.
3. Through original holes in chassis members put bolts M10x60mm (pos. 8) together with distance sleeves  $\varnothing 25 \times 6$ , L=31mm (pos.5) as shown in the figure 1.
4. Carefully put main bar of the towbar (pos. 1) to chassis members in this way so distance sleeves stay on right place and put bolt M10x60mm through holes pos. A and fix loosely.
5. In rest places of fastening fix towbar using bolts from equipment according to figure 1.
6. Reassemble the bumper after cut off elements as shown in the figure 2.
7. Fix tow-ball (pos. 2) and socket plate (pos. 3) by bolts M12x75mm (pos. 6) and M12x70mm (pos. 7) from equipment.
8. Fix tight all bolts according to the torque shown in the table.
9. Connect electric wires of 7-poles socket according to the instruction of the car. (Recommend to make at authorized service station)
10. Complete paint layer damaged during installation.

Figure 2

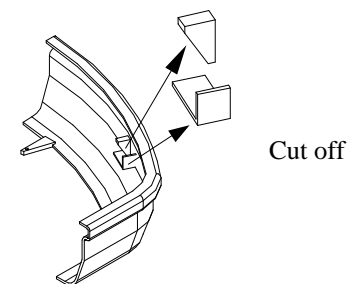

Torque settings for nuts and bolts (8,8):	
<b>M 8</b> - 25 Nm	<b>M 10</b> - 55 Nm
<b>M 12</b> - 85 Nm	<b>M 14</b> - 135 Nm

### NOTE

After install the towbar you should get adequate note in registration book (at authorised service station).The car should be equipped with:

- Indicators
- Tow mirrors

After 1000km of exploitation check all bolts and nuts. The ball of towbar must be always kept clear and conserve with a grease.