

FITTING INSTRUCTION

| Clamp mark in acc. with | | Cables joining |
|-------------------------|-----|---------------------------|
| ISO | PN | |
| 1 | L | Left directional lights |
| 2 | + | Rear fog lights |
| 3 | 31 | Ground |
| 4 | R | Right directional lights |
| 5 | 58R | Right side parking lights |
| 6 | 54 | Stoplights |
| 7 | 58L | Left side parking lights |

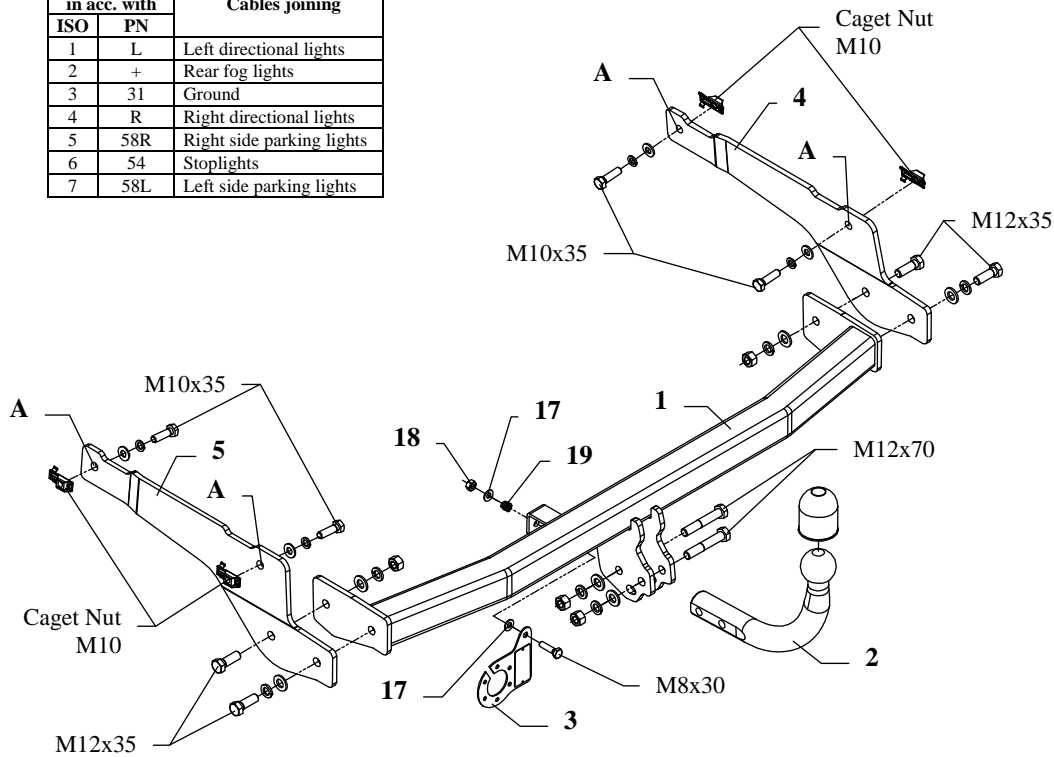

This towbar is designed to assembly in following car:
PEUGEOT 206 SW Estate, produced since 06.2002 till 12.2006,
 catalogue no. **F22** and is prepared to tow trailers max total weight **1100 kg**
 and max vertical load **50 kg**.

From manufacturer

Thank you for buying our product. Their reliability has been confirmed in many tests. Reliability of towbar depends also on correct assembly and right operation. For this reasons we kindly ask to read carefully this instruction and apply to hints.

The towbar should be install in points described by a car producer.

The instruction of the assembly

1. Put the special nut “Caget Nut” M10 to the chassis member’s holes on the left and right side, then fix the brackets (pos. 4 and 5) using M10x35mm (pos. 9) bolts.
2. Position the main bar of the towbar (pos. 1) between the brackets (pos. 4 and 5), and fix it using M12x35mm (pos. 8) bolts.
3. Position the ball of towbar (pos. 2) and fix with M12x70mm (pos. 7) bolts from the towbar accessories.
4. Fix the socket plate (pos. 3) as shown on the drawing.
5. Tighten all nuts and bolts according to the torque shown in the table.
6. Connect to the electric wires according to the instructions of the car.
7. Complete the paint cover of towbar (during the mounting paint cover could be destroyed).

Torque settings for nuts and bolts (8,8):

| | | | |
|-------------|-------|-------------|--------|
| M 8 | 25 Nm | M 10 | 55 Nm |
| M 12 | 85 Nm | M 14 | 135 Nm |











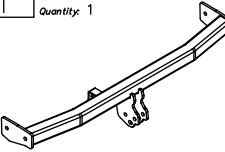
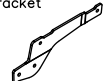



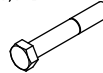

NOTE

After install the towbar you should get adequate note in registration book (at authorised service station). The car should be equipped with:

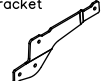
- Indicators
- Tow mirrors

After 1000km of exploitation check all bolts and nuts. The ball of towbar must be always kept clear and conserve with a grease.

Towbar accessories:

| | | | |
|---|---|---|--|
| Pos. 1 Name: Main bar Quantity: 1 | Pos. 5 Name: Left bracket Quantity: 1 | Pos. 10 Name: Nut 8 B Quantity: 4 Dim.: M12 | Pos. 15 Name: Ball cover Quantity: 1 |
|  |  |  |  |
| Pos. 2 Name: Tow ball Quantity: 1 | Pos. 6 Name: Caget nut Quantity: 4 Dim.: M10 | Pos. 11 Name: Plain washer Quantity: 6 Dim.: Ø 13 mm | Pos. 16 Name: Bolt 8,8 B Quantity: 1 Dim.: M8x30mm |
|  |  |  |  |
| Pos. 3 Name: Socket plate Quantity: 1 | Pos. 7 Name: Bolt 8,8 B Quantity: 2 Dim.: M12x70mm | Pos. 12 Name: Plain washer Quantity: 4 Dim.: Ø 10,5 mm | Pos. 17 Name: Plain washer Quantity: 2 Dim.: Ø 8,5 mm |
|  |  |  |  |
| Pos. 4 Name: Right bracket Quantity: 1 | Pos. 8 Name: Bolt 8,8 B Quantity: 4 Dim.: M12x35mm | Pos. 13 Name: Spring washer Quantity: 6 Dim.: Ø 12,2 mm | Pos. 18 Name: Nut 8 B Quantity: 1 Dim.: M8 |
|  |  |  |  |
| | Pos. 9 Name: Bolt 8,8 B Quantity: 4 Dim.: M10x35mm | Pos. 14 Name: Spring washer Quantity: 4 Dim.: Ø 10,2 mm | Pos. 19 Name: Spring Quantity: 1 |
| |  |  |  |



PPUH AUTO-HAK S. J.

Produkcja Zaczepów Kulowych
Henryk & Zbigniew Nejman
76-200 SŁUPSK ul. Słoneczna 16K
tel/fax (059) 8-414-414; 8-414-413
E-mail: office@autohak.com.pl
www.autohak.com.pl

Towing hitch (without electrical set)

Class: **A50-X** Cat. no. **F22**

Designed for:

Manufacturer: **PEUGEOT**

Model: **206**

Type: **SW (ESTATE)**

produced since 06.2002 till 12.2006

Technical data:

D-value: 6,21 kN

maximum trailer weight: **1100 kg**

maximum vertical cup load: **50 kg**

Approval number acc. to regulations EKG/ONZ 55.01: **E20-55R-01 1246**

Foreword

This towbar is designed according to rules of safety traffic regulations. The towing hitch is a safety component and can be install only by qualified personnel. Any alteration or conversion of the towing hitch is prohibited and would lead to cancellation of design certification. Remove insulating compound and underseal from vehicle (if present) in the area of the matting surfaces of the towing hitch. The vehicle manufacturer's specifications regarding trailer load and max. vertical cup load are decisive for driving whereat values for the towing hitch cannot be exceeded.

D-value formula:

$$\frac{\text{Max trailer weight [kg]} \times \text{Max vehicle weight [kg]}}{\text{Max trailer weight [kg]} + \text{Max vehicle weight [kg]}} \times \frac{9,81}{1000} = D \text{ [kN]}$$