

FITTING INSTRUCTION

Clamp mark in acc. with		Cables joining
ISO	PN	
1	L	Left directional lights
2	+	Rear fog lights
3	31	Ground
4	R	Right directional lights
5	58R	Right side parking lights
6	54	Stoplights
7	58L	Left side parking lights

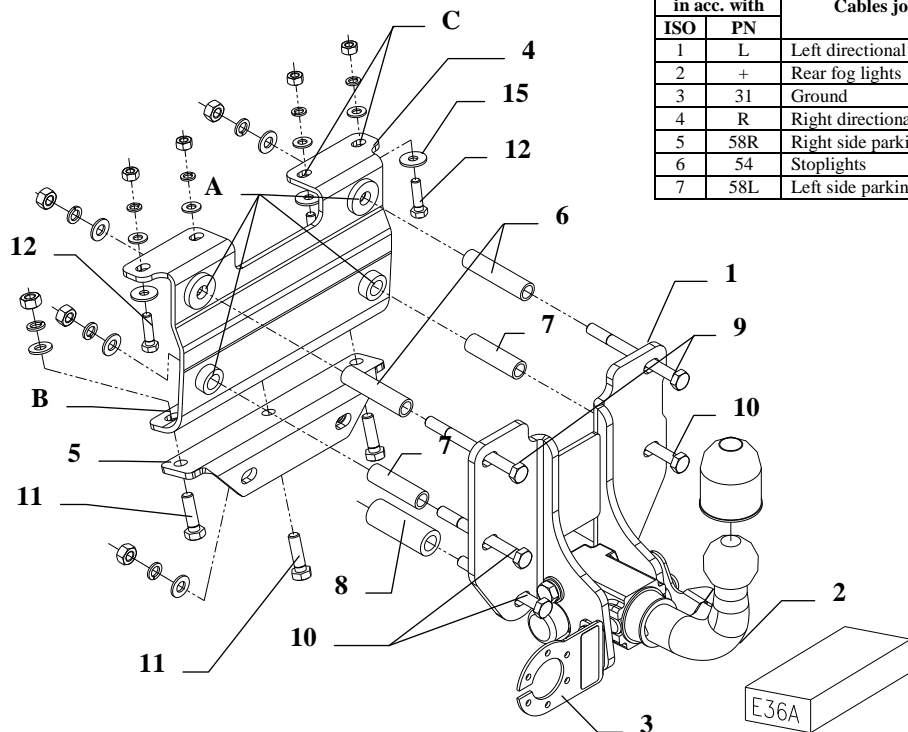

This towbar is designed to assembly in following cars:
OPEL ASTRA F ESTATE, produced since 09.1991 till 2002, catalogue no. **E36A** and is prepared to tow trailers max total weight **1500 kg** and max vertical load **50 kg**.

From manufacturer

Thank you for buying our product. Their reliability has been confirmed in many tests. Reliability of towbar depends also on correct assembly and right operation. For this reasons we kindly ask to read carefully this instruction and apply to hints.

The towbar should be install in points described by a car producer.

The instruction of the assembly

1. Disassemble the bumper and take the spare wheel out of trunk.
2. Find original marked places in outside the rear panel, then drill four holes using drill $\varnothing 17\text{mm}$. If you want to make sure which holes are original, please position the bracket of the tow-ball (pos. 1).
3. Position the rear plate (pos. 4) to the trunk and fix it together with bracket of the tow-ball (pos. 1), through the original holes, towbar holes (pos. A) and sleeves using bolts M10x110mm (pos. 9) and M10x100mm (pos. 10).
4. Drill inside the trunk through the holes (pos. B) using drill $\varnothing 12\text{mm}$ and then fix it with the bottom plate (pos. 5) positioned at the bottom of the car using bolts M10x35mm (pos. 11).
5. Slide the sleeves $\varnothing 25 \times 6$, L=68mm (pos. 8) between elements (pos. 1 and 5) and fix it by bolts M10x100mm (pos. 10) - see the drawing.
6. Fix through the holes (pos. C) using bolts M8x30mm (pos. 12).
7. Cut the bumper (dimension is 70x35mm).
8. Reassemble the bumper.
9. Fix body of the automat and place tow-ball according to supplied instruction. Note! Remember to place socket plate (pos. 3) as shown on the drawing 1.
10. Tighten all bolts according to the torque shown in the table.
11. Connect electric wires of 7-poles socket according to the instruction of the car. (Recommend to make at authorized service station).
12. Complete paint layer damaged during installation.

Torque settings for nuts and bolts (8,8):

M6 - 11 Nm	M8 - 25 Nm	M10 - 50 Nm
M12 - 87 Nm	M14 - 138 Nm	M16 - 210 Nm

















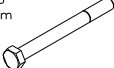

NOTE

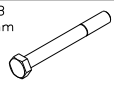
After install the towbar you should get adequate note in registration book (at authorised service station).The car should be equipped with:

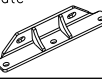
- Indicators
- Tow mirrors

Check all bolts and nuts after 1000km of exploitation. The ball of towbar must be always kept clear and conserve with a grease.

Towbar accessories:

Pos. 1 pcs.: 1	Bracket of ball 	Pos. 7 pcs.: 2	Distance sleeve II ø17,2xø12,5mm L=60mm 	Pos. 13 pcs.: 9	Plain washer ø10mm 	Pos. 19 pcs.: 4	Nut 8 B M8 
Pos. 2 pcs.: 1	Tow-ball E36A 	Pos. 8 pcs.: 2	Distance sleeve III ø25xø15mm L=68mm 	Pos. 14 pcs.: 4	Plain washer ø8mm 	Pos. 20 pcs.: 1	Ball cover 
Pos. 3 pcs.: 1	Socket plate 	Pos. 9 pcs.: 2	Bolt 8,8 B M10x110mm 	Pos. 15 pcs.: 4	Plain washer 24xø8,4x2mm 		
Pos. 4 pcs.: 1	Rear plate 	Pos. 10 pcs.: 4	Bolt 8,8 B M10x100mm 	Pos. 16 pcs.: 9	Spring washer ø10mm 		
Pos. 5 pcs.: 1	Bottom plate 	Pos. 11 pcs.: 3	Bolt 8,8 B M10x35mm 	Pos. 17 pcs.: 4	Spring washer ø8mm 		
Pos. 6 pcs.: 2	Distance sleeve I ø17,2xø12,5mm L=73mm 	Pos. 12 pcs.: 4	Bolt 8,8 B M8x30mm 	Pos. 18 pcs.: 9	Nut 8 B M10 		



PPUH AUTO-HAK Sp.J.

Produkcja Zaczepów Kulowych
Henryk & Zbigniew Nejman
76-200 SŁUPSK ul. Słoneczna 16K
tel/fax (059) 8-414-414; 8-414-413
E-mail: office@autohak.com.pl
www.autohak.com.pl

Towing hitch (without electrical set)

Class: **A50-X** Cat. no. **E36A**

Designed for:

Manufacturer: **OPEL**

Model: **ASTRA F**

Type: **ESTATE**

produced since 09.1991 till 2002

Technical data:

D-value: 7,77 kN

maximum trailer weight: **1500 kg**

maximum vertical cup load: **50 kg**

Approval number according to Directive 94/20/EC: **e20*94/20*1065*00**

Foreword

This towbar is designed according to rules of safety traffic regulations. The towing hitch is a safety component and can be install only by qualified personnel. Any alteration or conversion of the towing hitch is prohibited and would lead to cancellation of design certification. Remove insulating compound and underseal from vehicle (if present) in the area of the matting surfaces of the towing hitch. The vehicle manufacturer's specifications regarding trailer load and max. vertical cup load are decisive for driving whereat values for the towing hitch cannot be exceeded.

D-value formula:

$$\frac{\text{Max trailer weight [kg]} \times \text{Max vehicle weight [kg]}}{\text{Max trailer weight [kg]} + \text{Max vehicle weight [kg]}} \times \frac{9,81}{1000} = D \text{ [kN]}$$