

## FITTING INSTRUCTIONS

Oznaczenie zacisku wg ISO		PN	Łączenie przewodów
1	L		
2	+		Tylne światła przeciwmglowe
3	31		Masa
4	R		Kierunkowskazy prawe
5	58R		Światła pozycyjne prawe
6	54		Światła hamowania
7	58L		Światła pozycyjne lewe

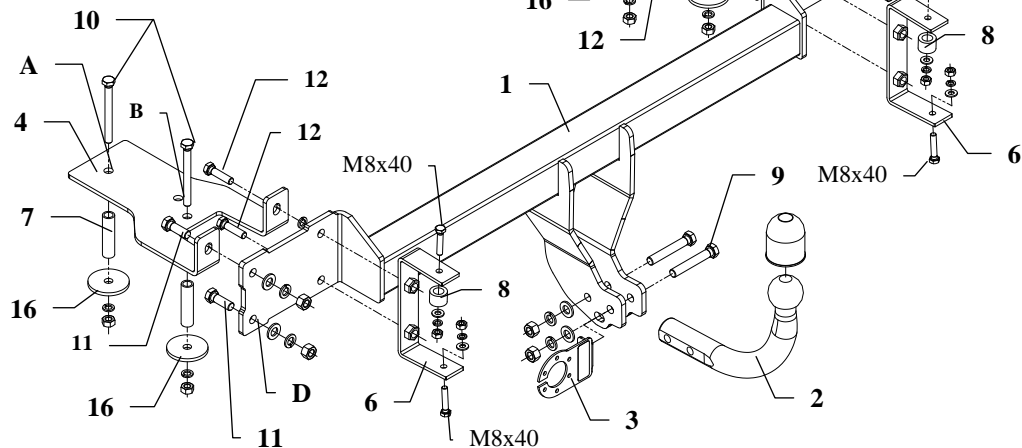

This towbar is designed to assembly in following car:

**KIA CLARUS 4 door**, produced since 02.1996 till 01.1999, catalogue no. **T07** and is prepared to tow trailers max total weight **1650 kg** and max vertical load **75 kg**.

### From manufacturer

Thank you for buying our product. Their reliability has been confirmed in many tests. Reliability of towbar depends also on correct assembly and right operation. For this reasons we kindly ask to read carefully this instruction and apply to hints.

*The towbar should be install in points described by a car producer.*

### Fitting instructions

1. Disassemble bumper .
2. Remove carpet from the boot.

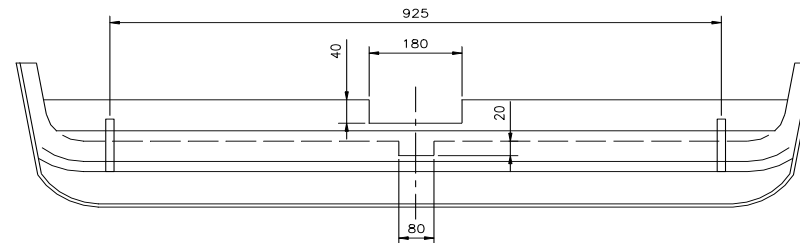
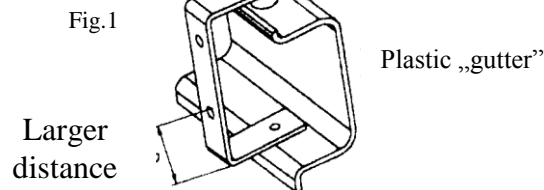

Fig. 2. Bumper's cut out

3. Put elements (pos. 4 and 5) to the trunk as shown in the fig. A. Hole (pos. A) put on existing hole next through hole pos. B mark points and drill it straight through.
  - Put away both fish plates (4 and 5) and next drill holes using bit  $\varnothing 17\text{mm}$  – only in boot floor.
4. On that prepared holes put distance sleeves  $L=68\text{ mm}$  (pos. 7).
  - Put fish plates (pos. 4 and 5), screw using bolts  $M10 \times 100\text{mm}$  (pos. 10), loosely, as shown in the drawing.
5. Main bar of the towbar (pos. 1) put to rear part of car and screw through holes (pos. C) using bolts  $M12 \times 35\text{mm}$  (pos. 11).
  - Through hole (pos. D) drill  $\varnothing 13\text{mm}$  and next screw using bolts  $M12 \times 35\text{mm}$  (pos. 11).
6. Install bumper after unscrew original handles of plastic „gutter” (not used any more). In places of unscrewed handles screw handles from towbar accessories (pos. 6) use distance sleeves (pos. 8) as shown in the fig. 1.
  - In plastic „gutter” (in axis) cut out his fragment  $180 \times 40$ , and next in bottom part of bumper cut out fragment  $80 \times 20$ , as shown in fig. 2.
7. Fix tow-ball (pos. 2) and socket plate (pos. 3) by bolts  $M12 \times 75\text{mm}$  (pos. 4) from accessories.
8. Connect electric wires of 7-poles socket according to the instruction of the car. (Recommend to make at authorized service station).
9. Complete the paint coating damaged during installation.

Torque settings for nuts and bolts (8,8):

**M 8 - 25 Nm**                      **M 10 - 55 Nm**  
**M 12 - 85 Nm**                      **M 14 - 135 Nm**











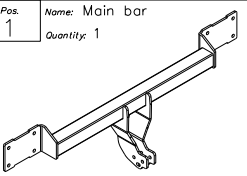





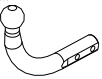

### NOTE

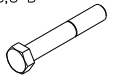
After install the towbar you should get adequate note in registration book (at authorised service station).The car should be equipped with:

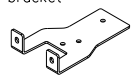
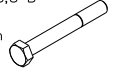
- Indicators
- Tow mirrors

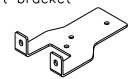
After 1000km check all bolts and nuts. The ball of towbar must be always kept clear and conserve with a grease.

## Towbar accessories:

Pos. 1 Name: Main bar Quantity: 1 	Pos. 6 Name: Handle Quantity: 2 	Pos. 12 Name: Bolt 8,8 B Quantity: 4 Dim.: M10x40mm 	Pos. 18 Name: Plain washer Quantity: 4 Dim.: Ø 10,5 mm 
	Pos. 7 Name: Distance sleeve I Quantity: 4 Dim.: Ø17,2x2,35mm L=58mm 	Pos. 13 Name: Nut 8 B Quantity: 6 Dim.: M12 	Pos. 19 Name: Plain washer Quantity: 4 Dim.: Ø 8,5 mm 
Pos. 2 Name: Tow ball Quantity: 1 	Pos. 8 Name: Distance sleeve II Quantity: 2 Dim.: Ø25x5mm L=18mm 	Pos. 14 Name: Nut 8 B Quantity: 4 Dim.: M10 	Pos. 20 Name: Spring washer Quantity: 6 Dim.: Ø 12,2 mm 
Pos. 3 Name: Socket plate Quantity: 1 	Pos. 9 Name: Bolt 8,8 B Quantity: 2 Dim.: M12x75mm 	Pos. 15 Name: Nut 8 B Quantity: 4 Dim.: M8 	Pos. 21 Name: Spring washer Quantity: 8 Dim.: Ø 10,2 mm 
Pos. 4 Name: Left bracket Quantity: 1 	Pos. 10 Name: Bolt 8,8 B Quantity: 4 Dim.: M10x100mm 	Pos. 16 Name: Washer Quantity: 4 Dim.: Ø58xØ12x5mm 	Pos. 22 Name: Spring washer Quantity: 4 Dim.: Ø 8,2 mm 
Pos. 5 Name: Right bracket Quantity: 1 	Pos. 11 Name: Bolt 8,8 B Quantity: 4 Dim.: M12x35mm 	Pos. 17 Name: Plain washer Quantity: 6 Dim.: Ø 13 mm 	Pos. 23 Name: Ball cover Quantity: 1 



**PPUH AUTO-HAK S.J.**

Produkcja Zaczepów Kulowych  
Henryk i Zbigniew Nejman  
76-200 SŁUPSK ul. Słoneczna 16K  
tel/fax (059) 8-414-414; 8-414-413  
Email: [office@autohak.com.pl](mailto:office@autohak.com.pl)  
[www.autohak.com.pl](http://www.autohak.com.pl)

## Towing hitch (without electrical set)

Class: **A50-X** Cat. no. **T07**

Designed for:

Manufacturer: **KIA**

Model: **CLARUS**

Type: **4 door**

produced since 02.1996 till 01.1999

Technical data:

**D-value: 8,4 kN**

maximum trailer weight: **1650 kg**

maximum vertical cup load: **75 kg**

Approval number according to Directive 94/20/EC: **e20\*94/20\*0613\*00**

## Foreword

This towbar is designed according to rules of safety traffic regulations. The towing hitch is a safety component and can be install only by qualified personnel. Any alteration or conversion of the towing hitch is prohibited and would lead to cancellation of design certification. Remove insulating compound and underseal from vehicle (if present) in the area of the matting surfaces of the towing hitch. The vehicle manufacturer's specifications regarding trailer load and max. vertical cup load are decisive for driving, and values for the towing hitch cannot be exceeded.

*D-value formula:*

$$\frac{\text{Max trailer weight [kg]} \times \text{Max vehicle weight [kg]}}{\text{Max trailer weight [kg]} + \text{Max vehicle weight [kg]}} \times \frac{9,81}{1000} = D \text{ [kN]}$$