

FITTING INSTRUCTION

Clamp mark in acc. with		Cables joining
ISO	PN	
1	L	Left directional lights
2	+	Rear fog lights
3	31	Ground
4	R	Right directional lights
5	58R	Right side parking lights
6	54	Stoplights
7	58L	Left side parking lights

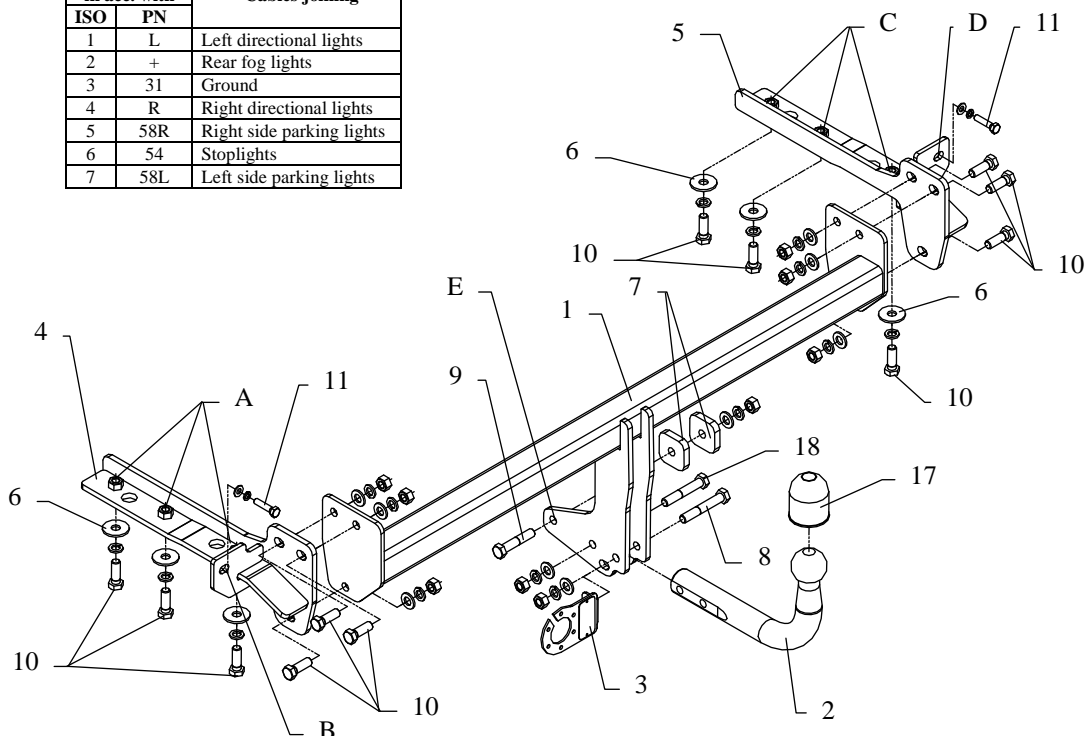

This towing hitch is designed to assembly in following cars:
HONDA FR-V, VAN produced since 02.2005 till 12.2010, catalogue no. **Y31** and is prepared to tow trailers max total weight **1500 kg** and max vertical load **90 kg**.

From manufacturer

Thank you for buying our product. Their reliability has been confirmed in many tests. Reliability of towing hitch depends also on correct assembly and correct exploitation. For this reasons we kindly ask to read carefully this instruction and apply to hints.

The towing hitch should be install in points described by a car producer.

The instruction of the assembly

- Disassemble the bumper
 - remove two bolts in left and right wheel housing
 - remove two plastic bolts from below and two from above the bumper
- Loosen plastic covers on the left and right side of the bumper.
- Remove bumper's filling (not used any more).
- Inside the bumper unscrew two inmost bolts.
- Fix element (pos. 4) through holes (pos. A) using bolts M12x35mm (pos. 10) – use washers (pos. 6) and through hole (pos. B) using bolt M8x35mm (pos. 11), see figure 1.
- Fix element (pos. 5) through holes (pos. C) using bolts M12x35mm (pos. 10) – use washers (pos. 6) and through hole (pos. D) using bolt M8x35mm (pos. 11), see figure 1.
- Between installed elements (pos. 4 and 5) put main bar of the towing hitch (pos. 1) and fix it using bolts M12x35mm (pos. 10).
- Fix main bar of the towing hitch with original tow eye through hole (pos. E) using bolt M12x60mm (pos. 9), use square distance sleeves (pos. 7).

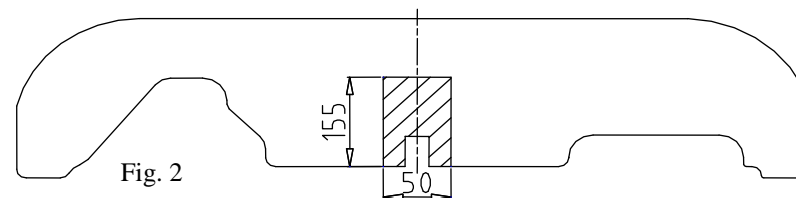

- Reassemble the bumper after cut out his fragment – see figure 2.
- Fix tow-ball (pos. 2) and socket plate (pos. 3) using bolts M12x75mm (pos. 8) and M12x70mm (pos. 18) from accessories .
- Tighten all bolts according to the torque shown in the table.
- Connect electric wires of 7-poles socket according to the instruction of the car. (Recommend to make at authorized service station)
- Complete paint layer damaged during installation.

Torque settings for nuts and bolts (8,8):	
M 8 - 25 Nm	M 10 - 55 Nm
M 12 - 85 Nm	M 14 - 135 Nm











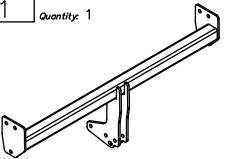
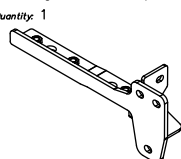

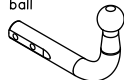
NOTE

After install the towing hitch you should get adequate note in registration book (at authorised service station).The car should be equipped with:

- Indicators
- Tow mirrors

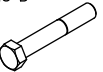
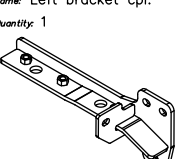
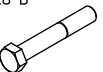
After 1000km check all bolts and nuts. The ball of towing hitch must be always kept clear and conserve with a grease.

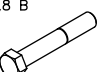
Towing hitch accessories:

Pos. 1 Name: Main bar Quantity: 1 	Pos. 5 Name: Right bracket cpl. Quantity: 1 	Pos. 10 Name: Bolt 8,8 B Quantity: 12 Dim.: M12x35mm 	Pos. 16 Name: Spring washer Quantity: 2 Dim.: Ø 8,2 mm 
Pos. 2 Name: Tow ball Quantity: 1 	Pos. 6 Name: Washer Quantity: 6 Dim.: Ø37xØ13x3mm 	Pos. 11 Name: Bolt 8,8 B Quantity: 2 Dim.: M8x35mm 	Pos. 17 Name: Ball cover Quantity: 1 
Pos. 3 Name: Socket plate Quantity: 1 	Pos. 7 Name: Distance washer Quantity: 2 Dim.: 48x48x10mm 	Pos. 12 Name: Nut 8 B Quantity: 9 Dim.: M12 	Pos. 18 Name: Bolt 8,8 B Quantity: 1 Dim.: M12x70mm 
Pos. 4 Name: Left bracket cpl. Quantity: 1 	Pos. 8 Name: Bolt 8,8 B Quantity: 1 Dim.: M12x75mm 	Pos. 13 Name: Plain washer Quantity: 9 Dim.: Ø 13 mm 	
	Pos. 9 Name: Bolt 8,8 B Quantity: 1 Dim.: M12x60mm 	Pos. 14 Name: Plain washer Quantity: 2 Dim.: Ø 8,5 mm 	
		Pos. 15 Name: Spring washer Quantity: 15 Dim.: Ø 12,2 mm 	



PPUH AUTO-HAK S.J.

Produkcja Haków Holowniczych
Henryk i Zbigniew Nejman
76-200 SŁUPSK ul. Słoneczna 16K
tel/fax (059) 8-414-414; 8-414-413
E-mail: office@autohak.com.pl
www. autohak.com.pl

Towing hitch (without electrical set)

Class: **A50-X** Cat. no. **Y31**

Designed for:

Manufacturer: **HONDA**

Model: **FR-V**

Type: **VAN**

produced since 02.2005 till 12.2010

Technical data:

D-value: 8,70 kN

maximum trailer weight: **1500 kg**

maximum vertical cup load: **90 kg**

Approval number acc. to regulations EKG/ONZ 55.01: E20-55R-01 1796

Foreword

This towing hitch is designed according to rules of safety traffic regulations. The towing hitch is a safety component and can be install only by qualified personnel. Any alteration or conversion of the towing hitch is prohibited and would lead to cancellation of design certification. Remove insulating compound and underseal from vehicle (if present) in the area of the matting surfaces of the towing hitch. The vehicle manufacturer's specifications regarding trailer load and max. vertical cup load are decisive for driving, and values for the towing hitch cannot be exceeded.

D-value formula:

$$\frac{\text{Max trailer weight [kg]} \times \text{Max vehicle weight [kg]}}{\text{Max trailer weight [kg]} + \text{Max vehicle weight [kg]}} \times \frac{9,81}{1000} = D \text{ [kN]}$$