

## FITTING INSTRUCTION

Clamp mark in acc. with		Cables joining
ISO	PN	
1	L	Left directional lights
2	+	Rear fog lights
3	31	Ground
4	R	Right directional lights
5	58R	Right side parking lights
6	54	Stoplights
7	58L	Left side parking lights

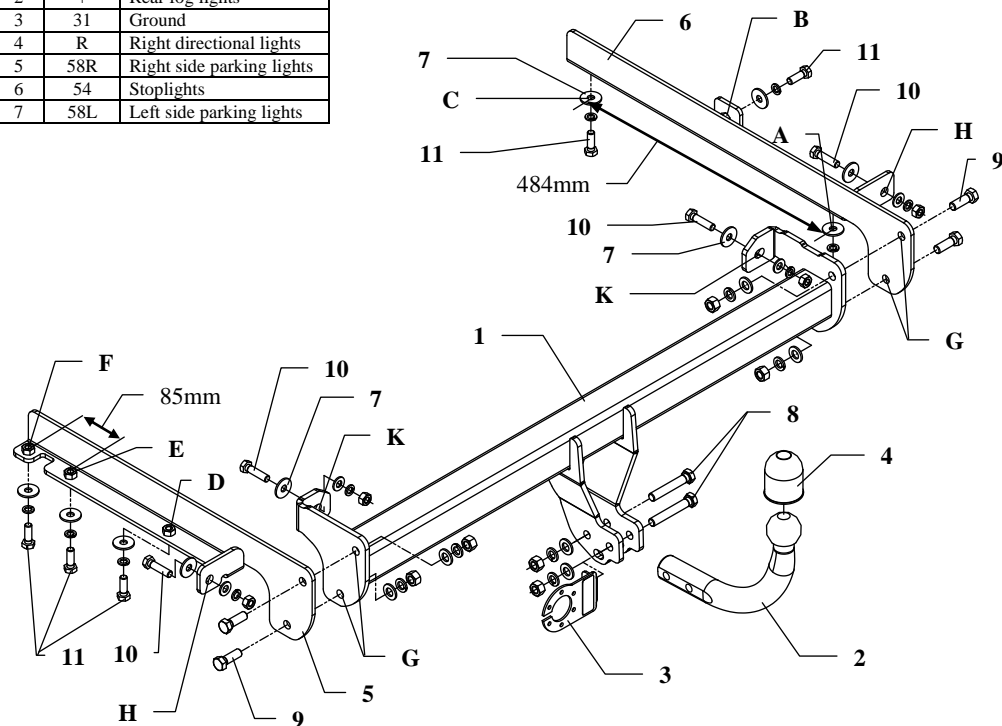

This towing hitch is designed to assembly in following cars:  
**HONDA CIVIC AERODECK ESTATE**, produced since 1997 till 02.2001, catalogue no. **Y05** and is prepared to tow trailers max total weight up to **1300 kg** and max vertical mass **50 kg**.

### *From manufacturer*

Thank you for buying our product. Their reliability has been confirmed in many tests. Reliability of towing hitch depends also on correct assembly and right operation. For this reasons we kindly ask to read carefully this instruction and apply to hints.

*The towing hitch should be install in points described by a car producer.*

## The instruction of the assembly

1. Before install our towing hitch please disassemble the bumper.
2. To left chassis member slip left bracket (pos. 5) and fix loosely from below the car using bolts M10x30mm (pos. 11), use big washers (pos. 7). Fix through original holes in chassis member and holes (pos. D and E) in the bracket.
3. To left chassis member slip left bracket (pos. 6) and fix loosely from below the car using bolts M10x30mm (pos. 11), use big washers (pos. 7). Fix through original holes in chassis members and holes (pos. A and B) in the bracket
4. On the left side, from hole (pos. E) measure 85mm (in axis) and make hole (pos. F)  $\varnothing 13$ mm. Fix using bolt M10x30mm (pos. 11).
5. On the right side, from hole (pos. A) measure 484mm (in axis) and make hole (pos. C)  $\varnothing 13$ mm. Fix using bolt M10x30mm (pos. 11).
6. Main bar of the towing hitch (pos. 1) fix with mounted brackets through holes (pos. G) using bolts M12x35mm (pos. 9).
7. Through original holes in rear panel and holes (pos. H and K) fix towing hitch using bolts M10x40mm (pos. 10) from accessories.
8. Fix tow-ball (pos. 2) and socket plate (pos. 3) using bolts M12x75mm (pos. 8) from the towing hitch accessories.
9. Tighten all bolts according to the torque shown in the table.
10. Connect electric wires of 7-poles socket according to the instruction of the car. (Recommend to make at authorized service station)
11. Complete paint layer damaged during installation.

Torque settings for nuts and bolts (8,8):

<b>M 8</b> - 25 Nm	<b>M 10</b> - 55 Nm
<b>M 12</b> - 85 Nm	<b>M 14</b> - 135 Nm











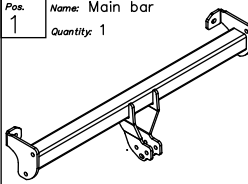

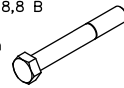

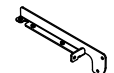
### NOTE

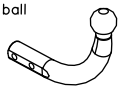
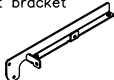
After install the towing hitch you should get adequate note in registration book (at authorised service station).The car should be equipped with:

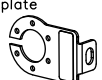
- Indicators
- Tow mirrors

After 1000km check all bolts and nuts. The ball of towing hitch must be always kept clear and conserve with a grease.

## Towing hitch accessories:

Pos. 1 Name: Main bar Quantity: 1 	Pos. 4 Name: Ball cover Quantity: 1 	Pos. 8 Name: Bolt 8,8 B Quantity: 2 Dim.: M12x75mm 	Pos. 13 Name: Nut 8 B Quantity: 4 Dim.: M10 
	Pos. 5 Name: Left bracket Quantity: 1 	Pos. 9 Name: Bolt 8,8 B Quantity: 4 Dim.: M12x35mm 	Pos. 14 Name: Plain washer Quantity: 6 Dim.: Ø 13 mm 
Pos. 2 Name: Tow ball Quantity: 1 	Pos. 6 Name: Right bracket Quantity: 1 	Pos. 10 Name: Bolt 8,8 B Quantity: 4 Dim.: M10x40mm 	Pos. 15 Name: Plain washer Quantity: 4 Dim.: Ø 10,5 mm 
Pos. 3 Name: Socket plate Quantity: 1 	Pos. 7 Name: Washer Quantity: 8 Dim.: Ø35xØ12x3mm 	Pos. 11 Name: Bolt 8,8 B Quantity: 6 Dim.: M10x30mm 	Pos. 16 Name: Spring washer Quantity: 6 Dim.: Ø 12,2 mm 
		Pos. 12 Name: Nut 8 B Quantity: 6 Dim.: M12 	Pos. 17 Name: Spring washer Quantity: 10 Dim.: Ø 10,2 mm 



**PPUH AUTO-HAK S.J.**

Produkcja Zaczepów Kulowych  
Henryk i Zbigniew Nejman  
76-200 SŁUPSK ul. Słoneczna 16K  
tel/fax (059) 8-414-414; 8-414-413  
E-mail: [office@autohak.com.pl](mailto:office@autohak.com.pl)  
[www.autohak.com.pl](http://www.autohak.com.pl)

## Towing hitch (without electrical set)

Class: **A50-X** Cat. no. **Y05**

Designed for:

Manufacturer: **HONDA**

Model: **CIVIC AERODECK**

Type: **ESTATE**

produced since 1997 till 02.2001

Technical data:

**D-value: 7,32 kN**

maximum trailer weight: **1300 kg**

maximum vertical cup mass: **50 kg**

**Approval number according to Directive 94/20/EC: e20\*94/20\*0505\*00**

## Foreword

This towing hitch is designed according to rules of safety traffic regulations. The towing hitch is a safety component and can be install only by qualified personnel. Any alteration or conversion of the towing hitch is prohibited and would lead to cancellation of design certification. Remove insulating compound and underseal from vehicle (if present) in the area of the matting surfaces of the towing hitch. The vehicle manufacturer's specifications regarding trailer load and max. vertical cup load are decisive for driving whereat values for the towing hitch cannot be exceeded.

*D-value formula:*

$$\frac{\text{Max trailer weight [kg]} \times \text{Max vehicle weight [kg]}}{\text{Max trailer weight [kg]} + \text{Max vehicle weight [kg]}} \times \frac{9,81}{1000} = D \text{ [kN]}$$