

FITTING INSTRUCTION

Clamp mark in acc. with		Cables joining
ISO	PN	
1	L	Left directional lights
2	+	Rear fog lights
3	31	Ground
4	R	Right directional lights
5	58R	Right side parking lights
6	54	Stoplights
7	58L	Left side parking lights

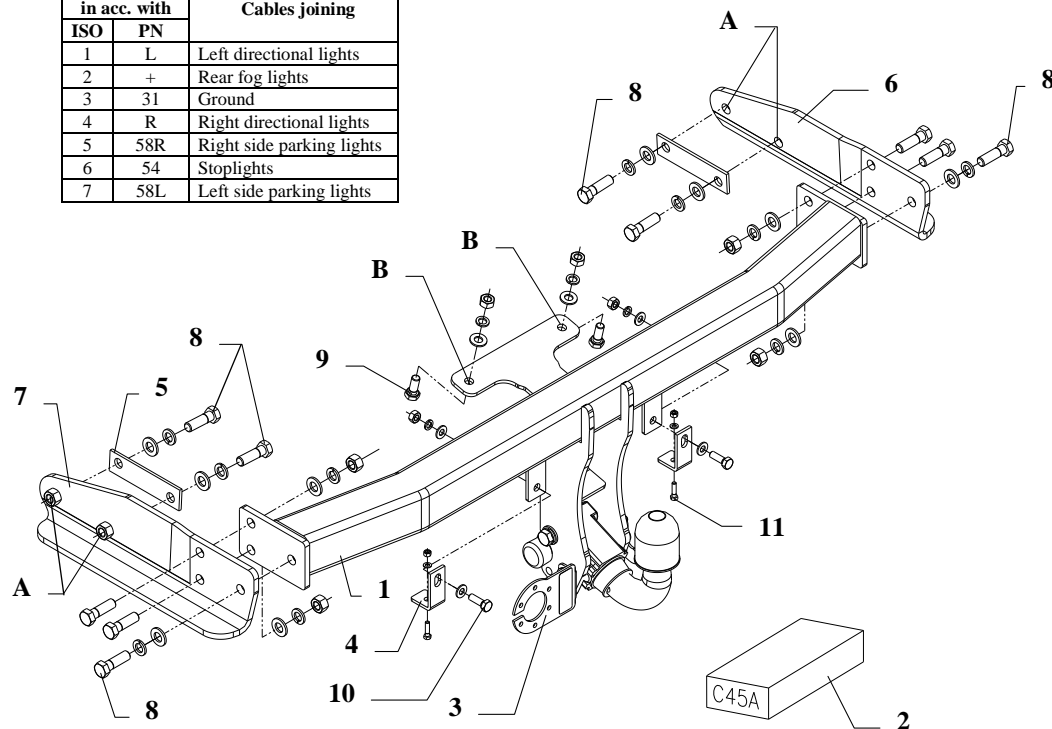

This towbar is designed to assembly in following cars:
FORD MAVERICK 3/5 door, produced since 01.2004 and **MAZDA TRIBUTE 5 door**, produced since 01.2004, catalogue no. **C45A** and is prepared to tow trailers max total weight **2000 kg** and max vertical load **75 kg**.

From manufacturer

Thank you for buying our product. Their reliability has been confirmed in many tests. Reliability of towbar depends also on correct assembly and right exploit. For this reasons we kindly ask to read carefully this instruction and apply to hints.

The towbar should be install in points described by a car producer.

The instruction of the assembly

1. Disassemble rear bumper together with metal reinforcement and plastic filler. Reinforcement will be not used any more. Twist nuts after reinforcement to original bolts.
2. On the left side of the car, get off the electric box. Unscrew two bolts in side element of chassis and get it off. Bolts twist again in original points.
3. In chassis members are small elements which can make some problems when You try to put side brackets (pos. 6 and 7). Bend him.
4. Slip side brackets (pos. 6 and 7) and fix it to chassis members through original holes pos. A and fish-plates pos. 5 using bolts M12x40mm (pos. 8) – loosely.
5. Between mounted brackets put body of the towbar (pos. 1) and fix it by bolts M12x40mm (pos. 8). Tighten all bolts.
6. To towbar, from upper side fix plastic filler and on the left side fix electric box.
7. In central part of towbar fix bumper handles (pos. 4) using bolts M8x25mm (pos. 10) and below the car through holes B using bolts M10x25mm (pos. 9).
8. Assemble the rear bumper after cut out fragment according to figure 2 or 3. Next fix bumper to the towbar using two bolts M5x20mm (pos. 11).
9. Tighten all bolts according to the torque shown in the table.
10. Fix body of the automat and place tow-ball according to supplied instruction. Note! Remember to place socket plate (pos. 3) as shown on the drawing 1.
11. Connect electric wires of 7-poles socket according to the instruction of the car. (Recommend to make at authorized service station)
12. Complete paint layer damaged during installation.

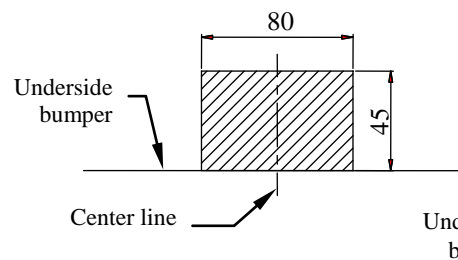

Fig. 2 Bumper cut out
Ford Maverick

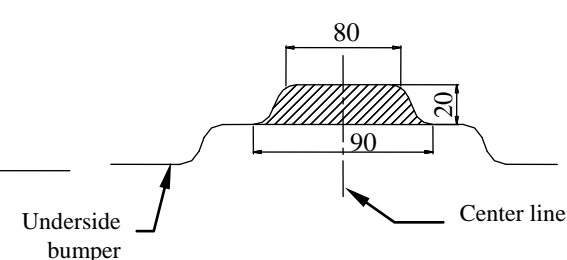

Fig. 3 Bumper cut out
Mazda Tribute











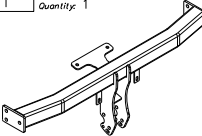
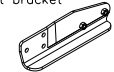



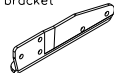





NOTE

After install the towbar you should get adequate note in registration book (at authorised service station).The car should be equipped with:

- Indicators
- Tow mirrors

After 1000km of exploitation check all bolts and nuts. The ball of towbar must be always kept clear and conserve with a grease.

Towbar accessories:

Pos. 1 Name: Main bar Quantity: 1 	Pos. 6 Name: Right bracket Quantity: 1 	Pos. 12 Name: Nut 8 B Quantity: 4 Dim.: M12 	Pos. 18 Name: Plain washer Quantity: 4 Dim.: Ø 8,5 mm 
Pos. 2 Name: Tow ball Quantity: 1 	Pos. 7 Name: Left bracket Quantity: 1 	Pos. 13 Name: Nut 8 B Quantity: 2 Dim.: M10 	Pos. 19 Name: Plain washer Quantity: 2 Dim.: Ø 5,3 mm 
Pos. 3 Name: Socket plate Quantity: 1 	Pos. 8 Name: Bolt 8,8 B Quantity: 10 Dim.: M12x40mm 	Pos. 14 Name: Nut 8 B Quantity: 2 Dim.: M8 	Pos. 20 Name: Spring washer Quantity: 10 Dim.: Ø 12,2 mm 
Pos. 4 Name: Handle Quantity: 2 	Pos. 9 Name: Bolt 8,8 B Quantity: 2 Dim.: M10x25mm 	Pos. 15 Name: Nut 8 B Quantity: 2 Dim.: M5 	Pos. 21 Name: Spring washer Quantity: 2 Dim.: Ø 10,2 mm 
Pos. 5 Name: Fish-plate Quantity: 2 	Pos. 10 Name: Bolt 8,8 B Quantity: 2 Dim.: M8x25mm 	Pos. 16 Name: Plain washer Quantity: 10 Dim.: Ø 13 mm 	Pos. 22 Name: Spring washer Quantity: 2 Dim.: Ø 8,2 mm 
	Pos. 11 Name: Bolt 8,8 B Quantity: 2 Dim.: M5x20mm 	Pos. 17 Name: Plain washer Quantity: 2 Dim.: Ø 10,5 mm 	



PPUH AUTO-HAK S.J.

Produkcja Zaczepów Kulowych
Henryk i Zbigniew Nejman
76-200 SŁUPSK ul. Słoneczna 16K
tel/fax (059) 8-414-414; 8-414-413
E-mail: office@autohak.com.pl
www.autohak.com.pl

Towing hitch (without electrical set)

Class: **A50-X** Cat. no. **C45A**

Designed for:
FORD MAVERICK 3/5 door
produced since 01.2004 and

MAZDA TRIBUTE 5 door
produced since 01.2004

Technical data:
D-value: 10,0 kN
maximum trailer weight: **2000 kg**
maximum vertical cup load: **75 kg**

Approval number according to Directive 94/20/EC: **e20*94/20*0930*00**

Torque settings for nuts and bolts (8,8):

M6 - 11 Nm	M8 - 25 Nm	M10 - 50 Nm
M12 - 87 Nm	M14 - 138 Nm	M16 - 210 Nm

Foreword

This towing hitch is designed according to rules of safety traffic regulations. The towing hitch is a safety component and can be install only by qualified personnel. Any alteration or conversion of the towing hitch is prohibited and would lead to cancellation of design certification. Remove insulating compound and underseal from vehicle (if present) in the areas of the matting surfaces of the towing hitch.

The vehicle manufacturer's specifications regarding trailer load and max. vertical cup mass are decisive for driving whereat values for the towing hitch cannot be exceeded.

D-value formula:

$$\frac{\text{Max trailer weight [kg]} \times \text{Max vehicle weight [kg]}}{\text{Max trailer weight [kg]} + \text{Max vehicle weight [kg]}} \times \frac{9,81}{1000} = D \text{ [kN]}$$