

FITTING INSTRUCTION

Clamp mark in acc. with		Cables joining
ISO	PN	
1	L	Left directional lights
2	+	Rear fog lights
3	31	Ground
4	R	Right directional lights
5	58R	Right side parking lights
6	54	Stoplights
7	58L	Left side parking lights

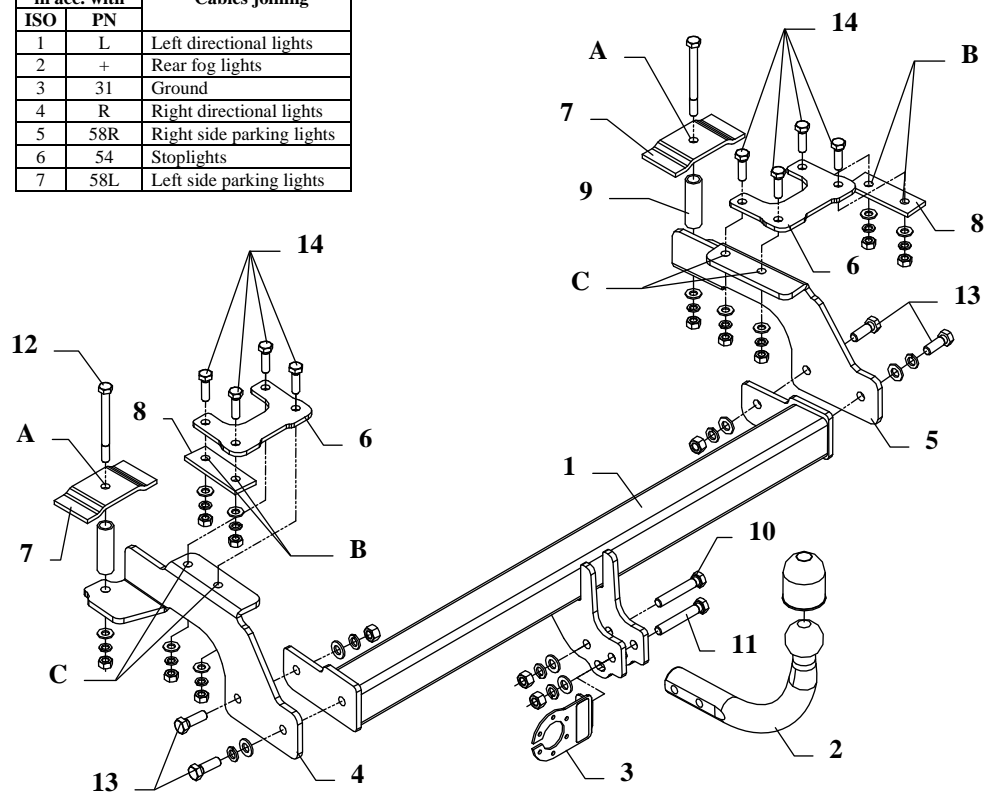

This towing hitch is designed to assembly in following cars: **VOLVO 460, 4 door**, produced since 08.1988 till 07.1993 and produced since 08.1993 till 07.1996, catalogue no. **L12** and is prepared to tow trailers max total weight **1200 kg** and max vertical load **75 kg**.

From manufacturer

Thank you for buying our product. Their reliability has been confirmed in many tests. Reliability of towing hitch depends also on correct assembly and right operation. For this reasons we kindly ask to read carefully this instruction and apply to hints.

The towing hitch should be install in points described by a car producer.

The instruction of the assembly

1. From the left and right side of the car drill to inside the carrier, holes to $\varnothing 12\text{mm}$ (pos. A), and then from inside the carrier bore to $\varnothing 22\text{mm}$.
2. Mark on the sides the points, and then drill to inside the carrier the holes (pos. B and C).
3. Inside the holes (pos. A) from the carrier put the distance sleeves $L=70\text{mm}$ (pos. 9) and apply two fish-plates (pos. 7).
4. Apply from the carrier two "U" fish-plates (pos. 6) on the holes (pos. B and C).
5. From the inside the chassis on the left and right side, apply the brackets (pos. 4 and 5) and twist across the holes (pos. C) with bolts M10x35mm (pos. 14) and by holes (pos. A) with bolts M10x110mm (pos. 12).
6. From the inside the chassis on the left and right side apply the side fish-plates (pos. 8) and twist across the holes (pos. B) with bolts M10x35mm and fish-plates "U" (pos. 6).

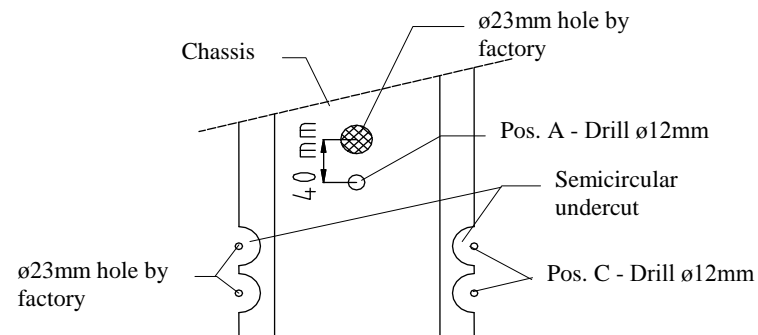

7. Between the mounted brackets (pos. 4 and 5) apply the main bar of the towing hitch (pos. 1) and twist with bolts M12x35mm (pos. 13) from the accessories.
8. Fix tow ball (pos. 2) using bolt M12x75mm (pos. 11) and M12x70mm (pos. 10). With bolt M12x75mm fix also a socket plate (pos. 3). See figure 1.
9. Tighten all bolts according to the torque shown in the table.
10. Connect electric wires of 7-poles socket according to the instruction of the car. (Recommend to make at authorized service station).
11. Complete paint layer damaged during installation.

Torque settings for nuts and bolts (8,8):	
M 8 - 25 Nm	M 10 - 55 Nm
M 12 - 85 Nm	M 14 - 135 Nm











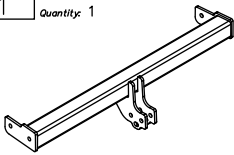

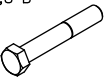

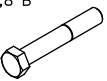

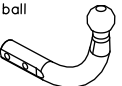

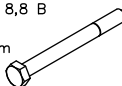

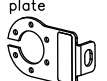
NOTE

After install the towing hitch you should get adequate note in registration book (at authorised service station).The car should be equipped with:

- Indicators
- Tow mirrors

After 1000km check all bolts and nuts. The ball of towing hitch must be always kept clear and conserve with a grease.

Towing hitch accessories:

Pos. 1 Name: Main bar Quantity: 1 	Pos. 5 Name: Right bracket Quantity: 1 Dim.: 361x168x110mm 	Pos. 10 Name: Bolt 8,8 B Quantity: 1 Dim.: M12x75mm 	Pos. 16 Name: Nut 8 B Quantity: 10 Dim.: M10 
	Pos. 6 Name: Fish-plate of the bracket Quantity: 2 Dim.: 141x95x6mm 	Pos. 11 Name: Bolt 8,8 B Quantity: 1 Dim.: M12x70mm 	Pos. 17 Name: Plain washer Quantity: 6 Dim.: Ø 13 mm 
Pos. 2 Name: Tow ball Quantity: 1 	Pos. 7 Name: Fish-plate of the bracket Quantity: 2 Dim.: 125x60x6mm 	Pos. 12 Name: Bolt 8,8 B Quantity: 2 Dim.: M10x110mm 	Pos. 18 Name: Plain washer Quantity: 10 Dim.: Ø 10,5 mm 
Pos. 3 Name: Socket plate Quantity: 1 	Pos. 8 Name: Fish-plate of the bracket Quantity: 2 Dim.: 100x35x6mm 	Pos. 13 Name: Bolt 8,8 B Quantity: 4 Dim.: M12x35mm 	Pos. 19 Name: Spring washer Quantity: 6 Dim.: Ø 12,2 mm 
Pos. 4 Name: Left bracket Quantity: 1 Dim.: 361x168x110mm 	Pos. 9 Name: Distance sleeve Quantity: 2 Dim.: Ø21.3x2.65mm, L=70mm 	Pos. 14 Name: Bolt 8,8 B Quantity: 8 Dim.: M10x35mm 	Pos. 20 Name: Spring washer Quantity: 10 Dim.: Ø 10,2 mm 
		Pos. 15 Name: Nut 8 B Quantity: 4 Dim.: M12 	Pos. 21 Name: Ball cover Quantity: 1 



PPUH AUTO-HAK Sp.J.

Produkcja Zaczepów Kulowych
Henryk i Zbigniew Nejman
76-200 SŁUPSK ul. Słoneczna 16K
tel/fax (059) 8-414-414; 8-414-413
E-mail: office@autohak.com.pl
www.autohak.com.pl

Towing hitch (without electrical set)

Class: **A50-X** Cat. no. **L12**

Designed for:

Manufacturer: **VOLVO**

Model: **460**

Type: **4 door**

produced since 08.1988 till 07.1993

and since 08.1993 till 07.1996

Technical data:

D-value: 6,76 kN

maximum trailer weight: **1200 kg**

maximum vertical cup load: **75 kg**

Approval number according to Directive 94/20/EC: **e20*94/20*0557*00**

Foreword

This towing hitch is designed according to rules of safety traffic regulations. The towing hitch is a safety component and can be install only by qualified personnel. Any alteration or conversion of the towing hitch is prohibited and would lead to cancellation of design certification. Remove insulating compound and underseal from vehicle (if present) in the area of the matting surfaces of the towing hitch. The vehicle manufacturer's specifications regarding trailer load and max. vertical cup load are decisive for driving, and values for the towing hitch cannot be exceeded.

D-value formula:

$$\frac{\text{Max trailer weight [kg]} \times \text{Max vehicle weight [kg]}}{\text{Max trailer weight [kg]} + \text{Max vehicle weight [kg]}} \times \frac{9,81}{1000} = D \text{ [kN]}$$